

# **ASSEMBLY INSTRUCTIONS**

---

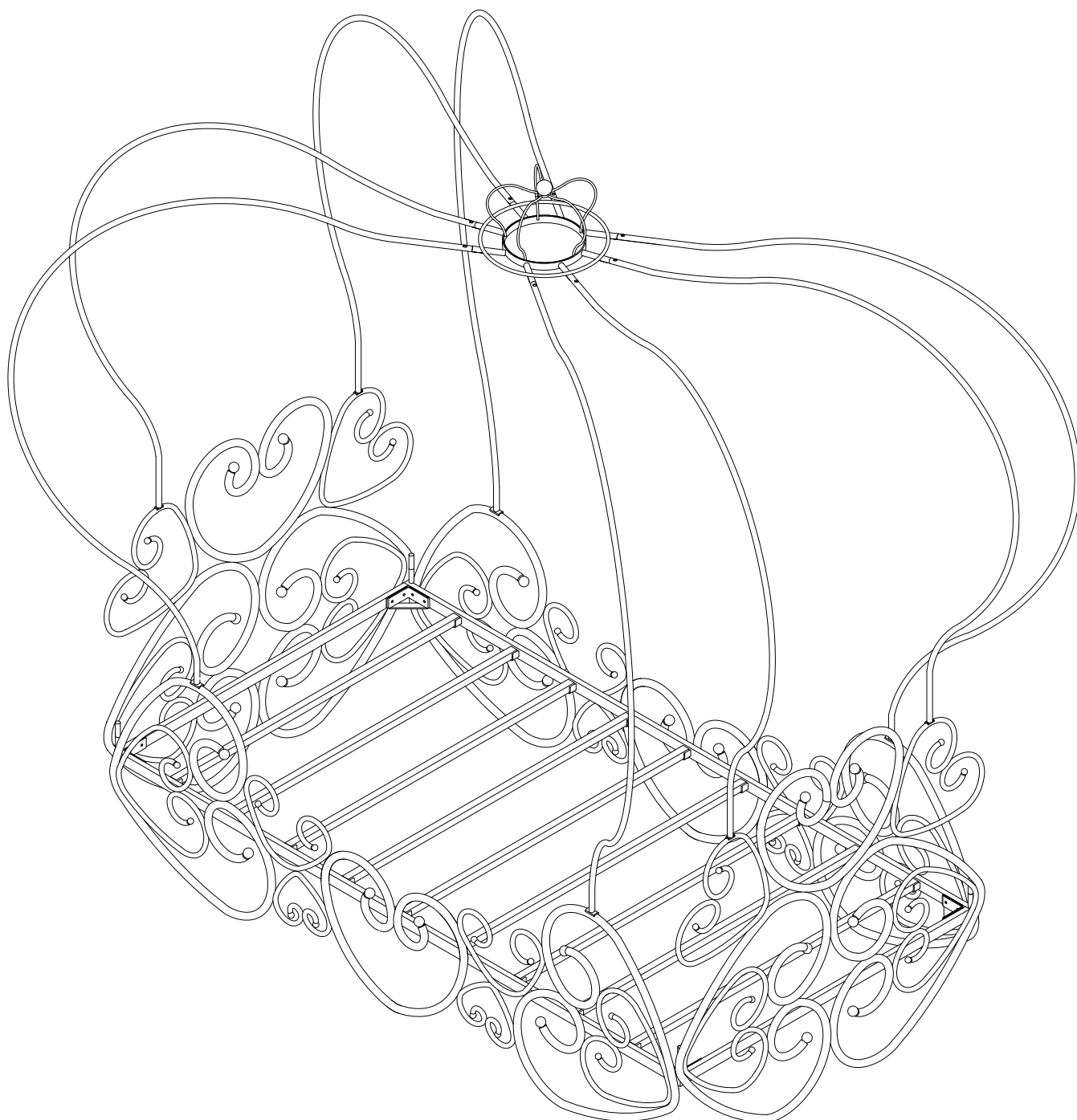

**MODEL 285593**



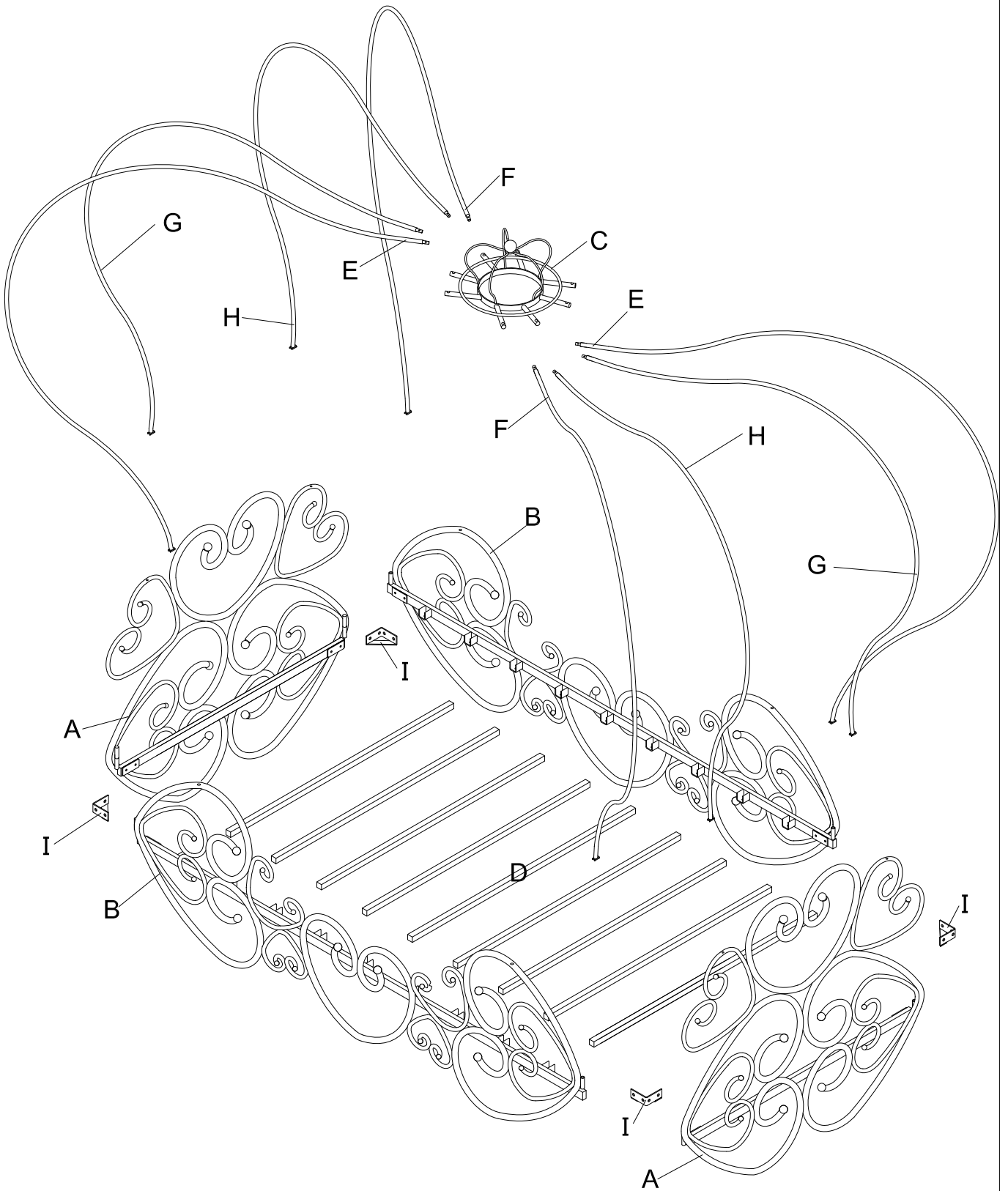

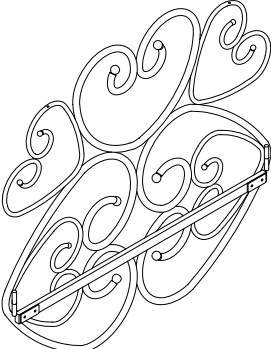
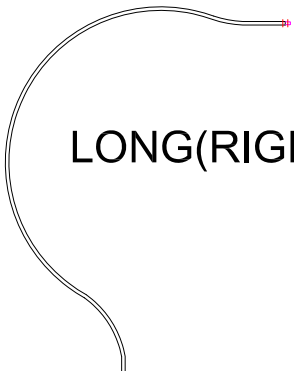
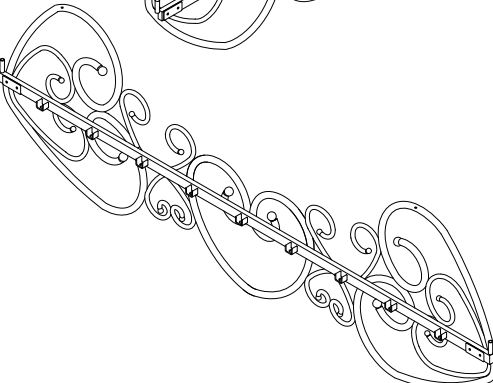
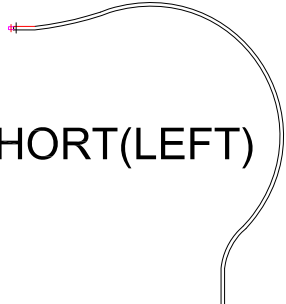
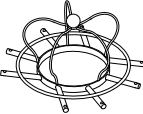
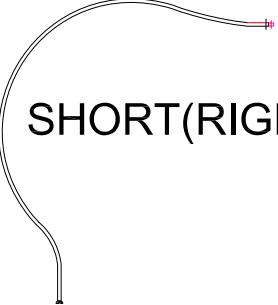
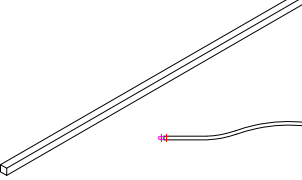

# PARTS IDENTIFICATION



# PARTS IDENTIFICATION

A		2pcs		F		LONG(RIGHT) 2pcs
B		2pcs		G		SHORT(LEFT) 2pcs
C		1pc		H		SHORT(RIGHT) 2pcs
D		9pcs		I		4pcs
E		2pcs				

## HARDWARE LIST

1		M6x30	4pcs
2		M6x20	4pcs
3		M6x15	16pcs
4		M6x10	8pcs
5			10pcs
6		4x4	1pc

# STEP 1.

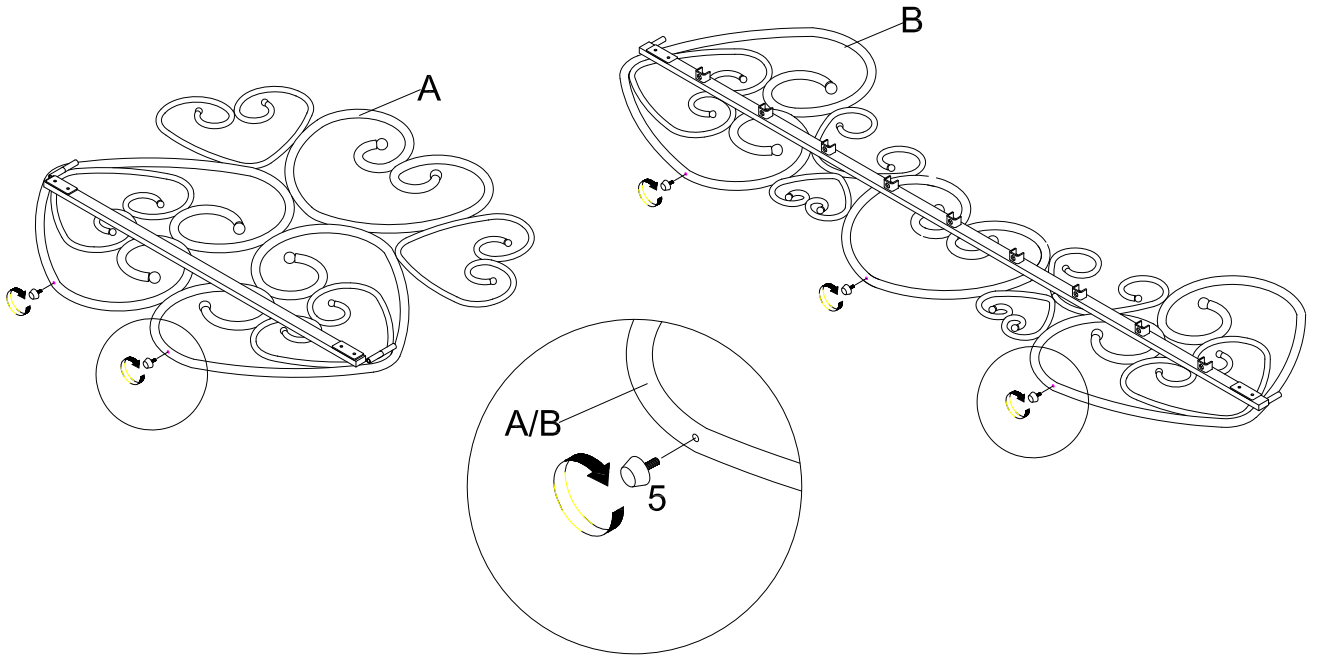

# STEP 2.

2-1

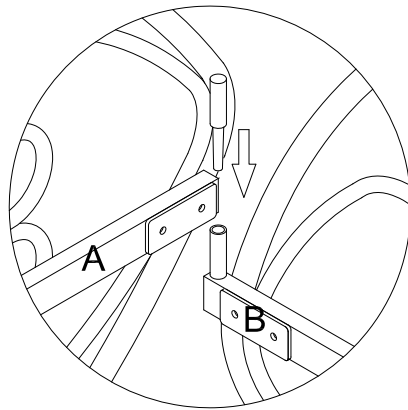

2-2

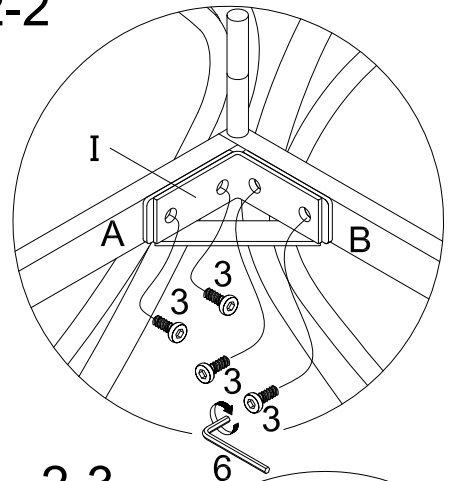

2-3

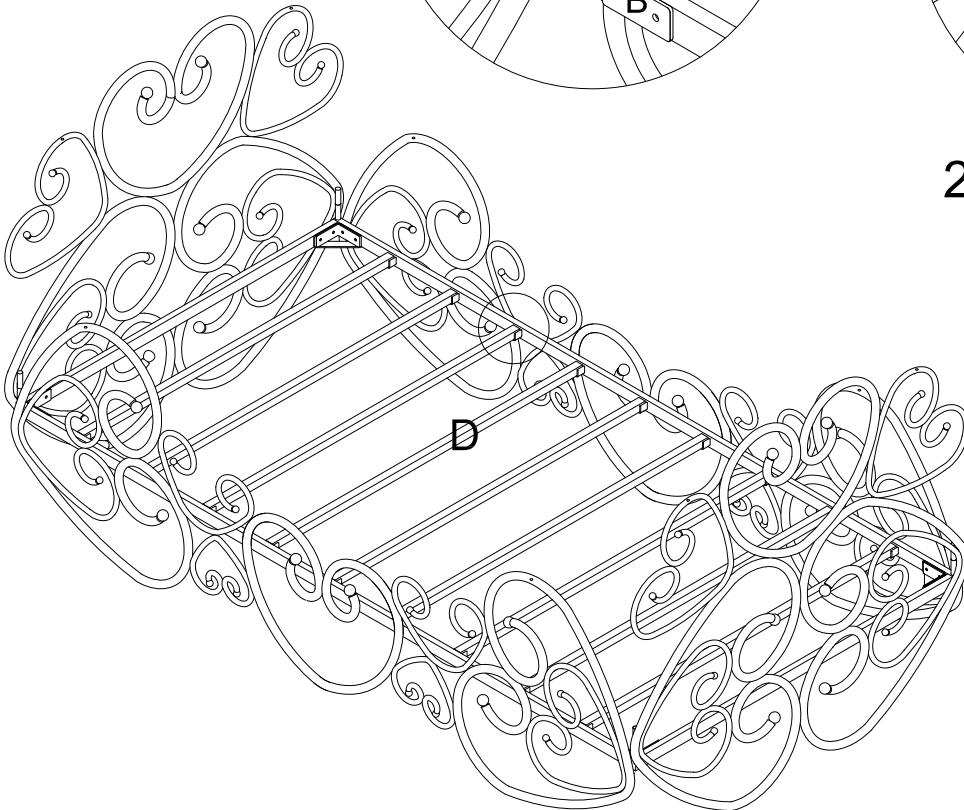
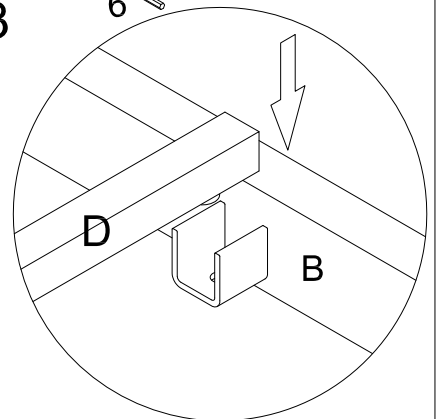

### STEP 3.

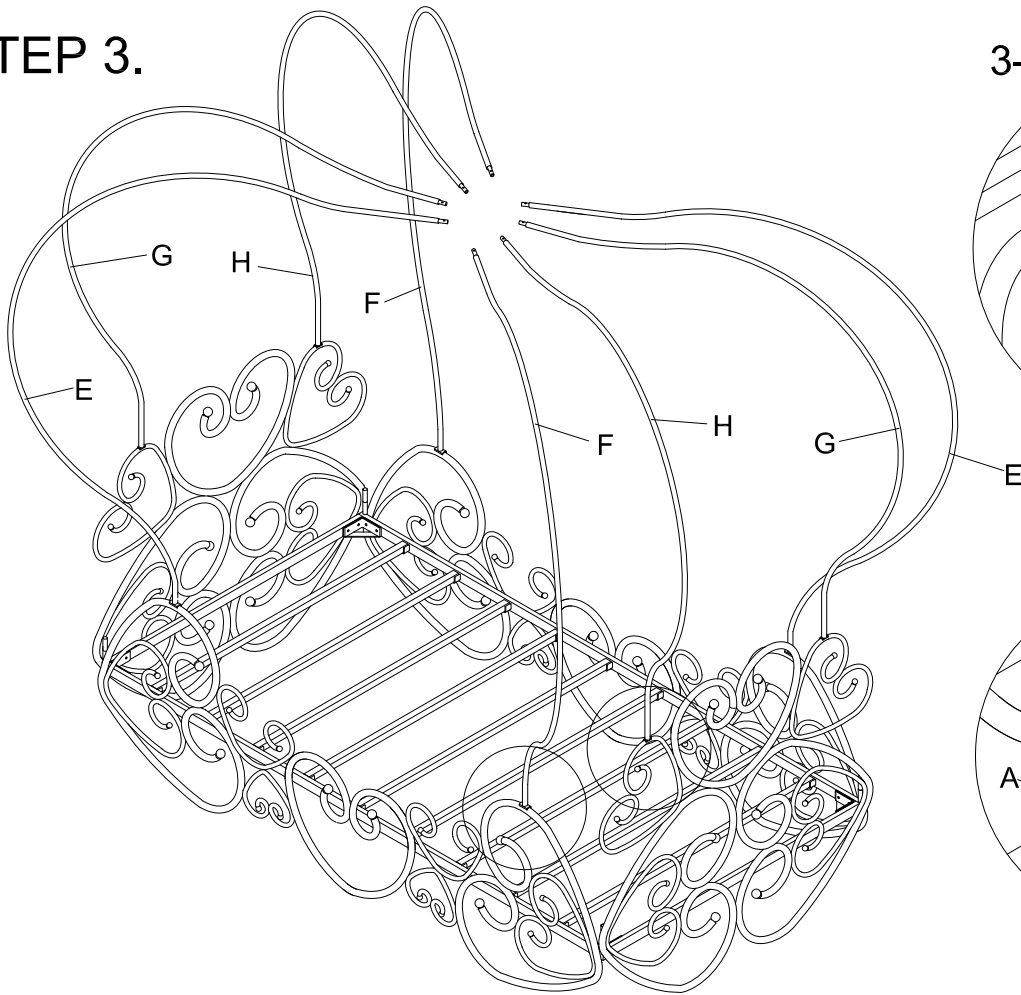

3-1

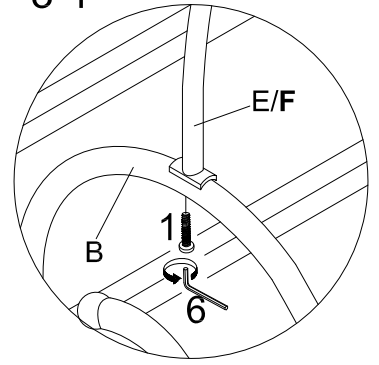

3-2

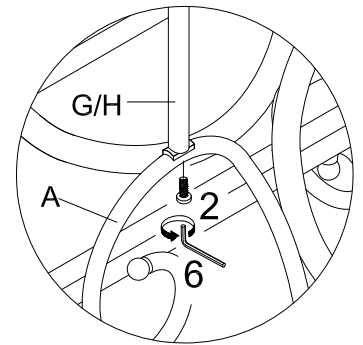

### STEP 4.

