

ASSEMBLY INSTRUCTIONS

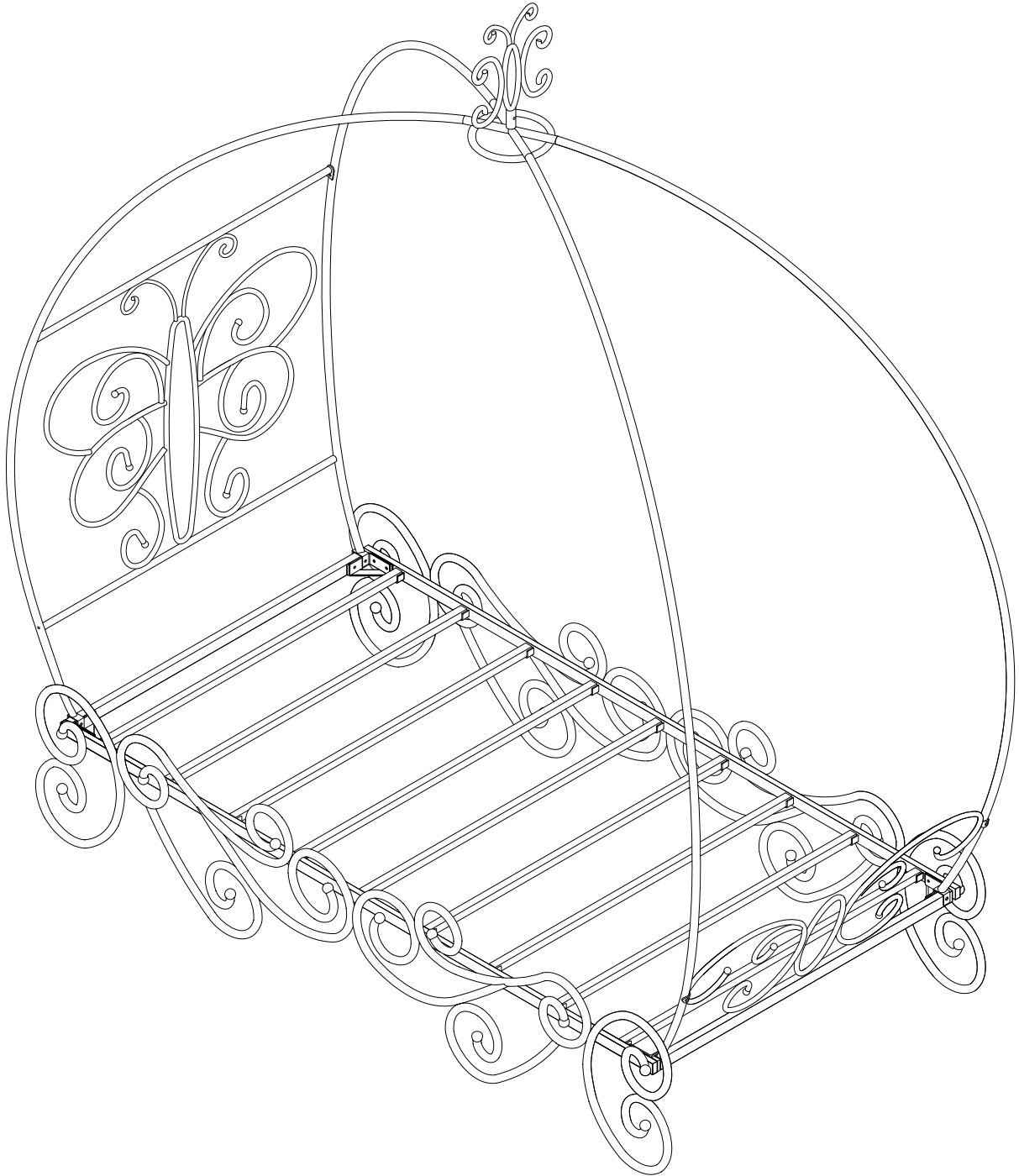

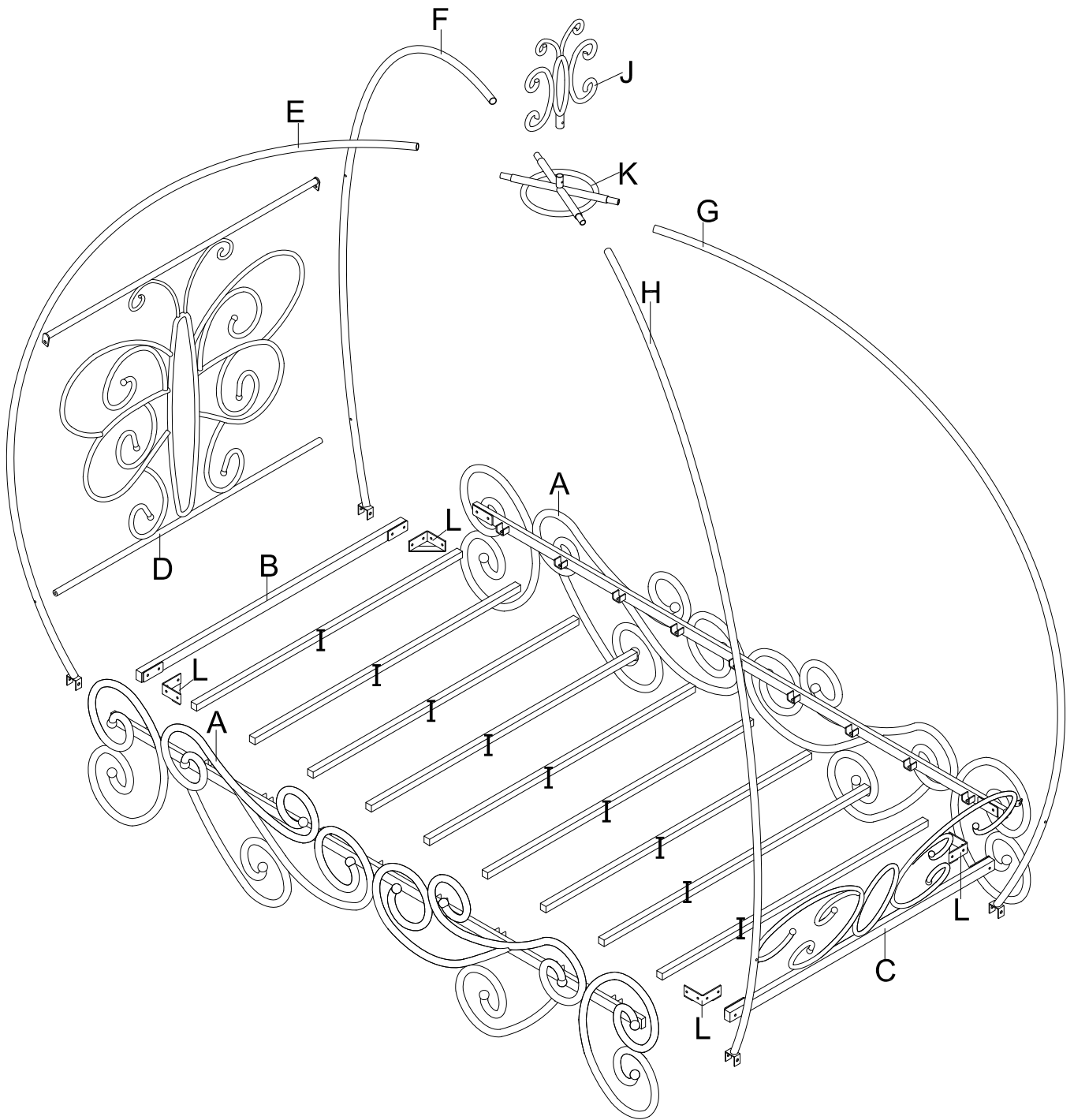



Do not tighten screws until completely assembled.



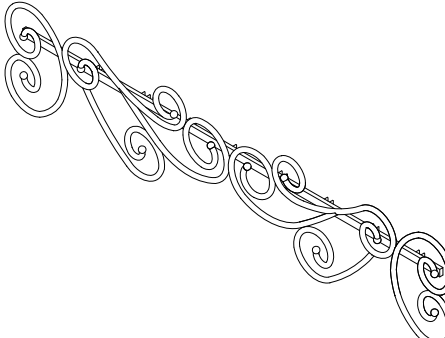
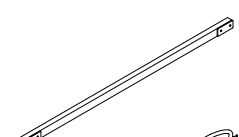
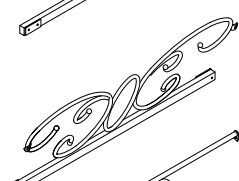
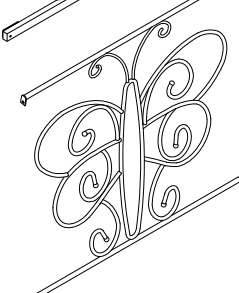
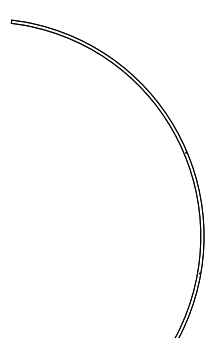
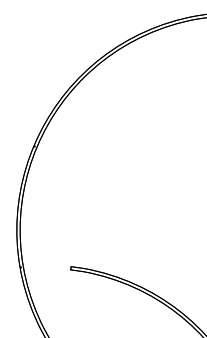
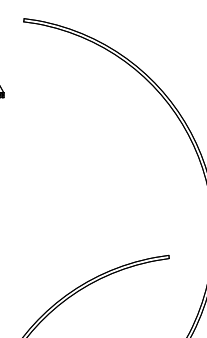
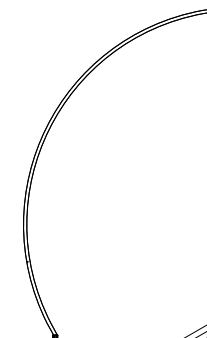
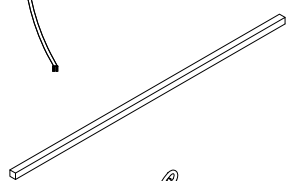

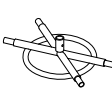
PARTS IDENTIFICATION

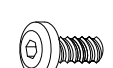

PARTS IDENTIFICATION

<p>A  2pcs</p> <p>B  1pc</p> <p>C  1pc</p> <p>D  1pc</p> <p>E  LEFT 1pc</p>	<p>F  RIGHT 1pc</p> <p>G  LEFT 1pc</p> <p>H  RIGHT 1pc</p> <p>I  9pcs</p> <p>J  1pc</p> <p>K  1pc</p> <p>L  4pcs</p>
--	---

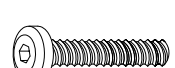
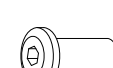
HARDWARE LIST

<p>1  21pcs M6x15</p>	<p>2  4pcs M6x25</p>	<p>3  2pcs M6x30</p>
<p>4  4pcs M6x18</p>	<p>5  2pcs 4x4</p>	

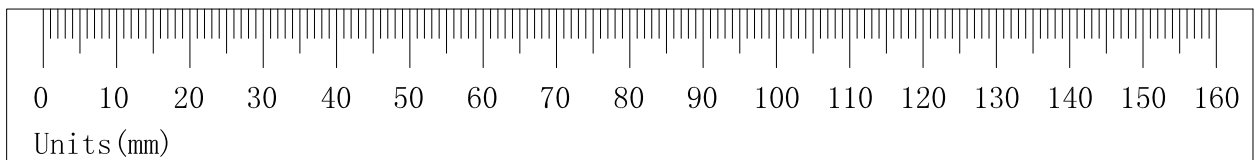



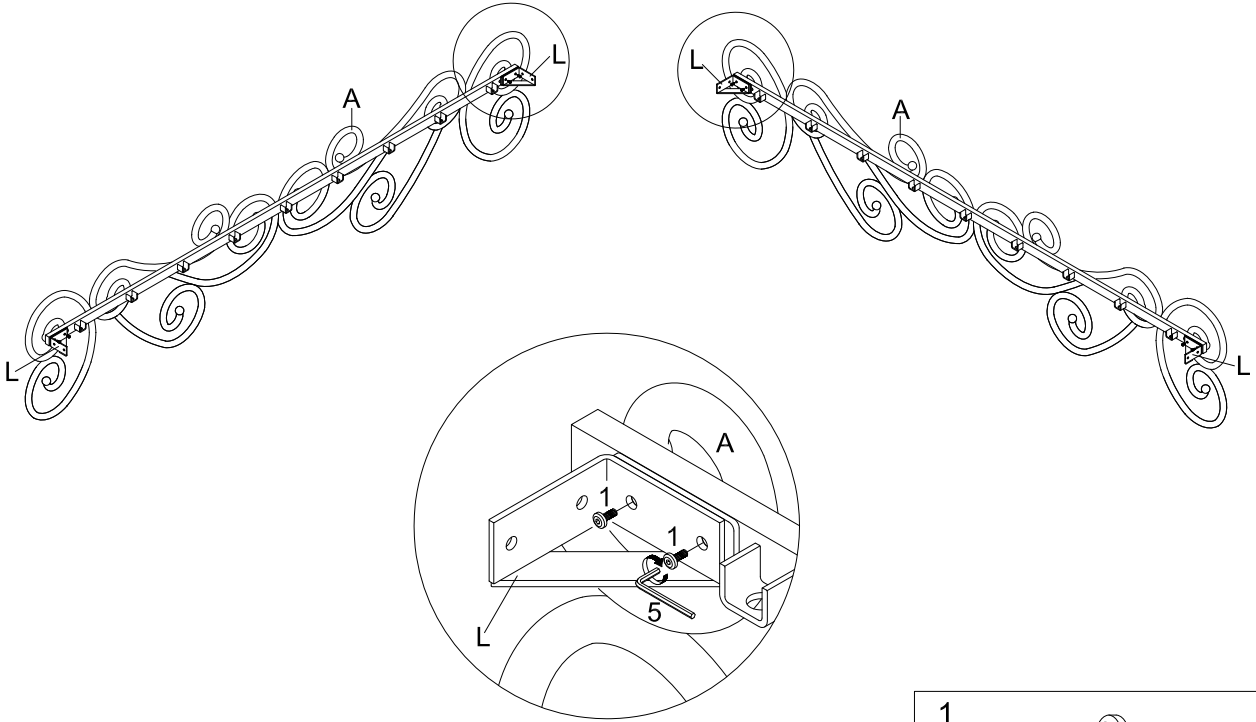

STEP 1.

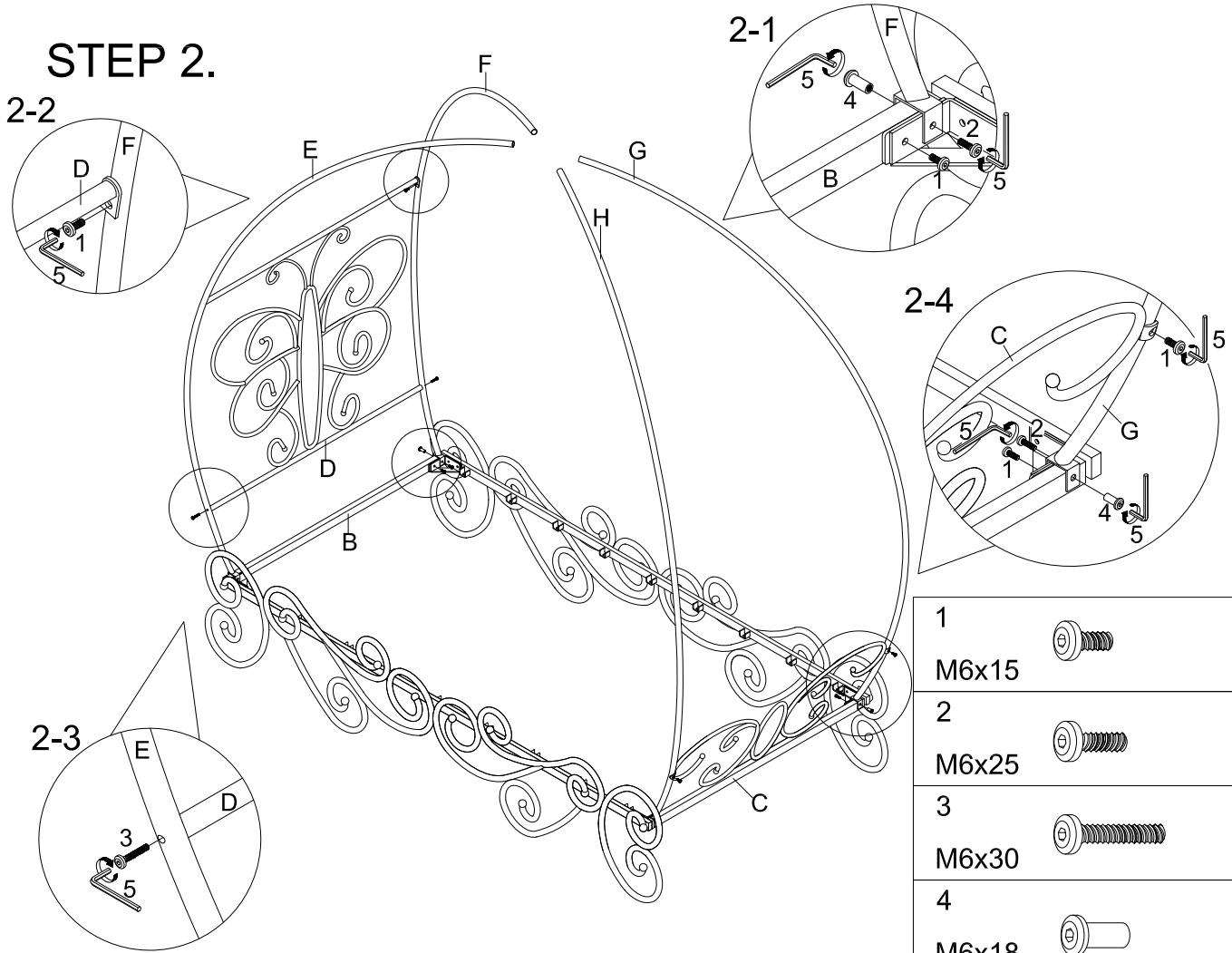

1		8pcs
M6x15		

STEP 2.



1		8pcs
M6x15		
2		4pcs
M6x25		
3		2pcs
M6x30		
4		4pcs
M6x18		

STEP 3.

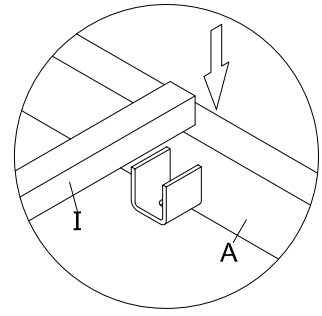
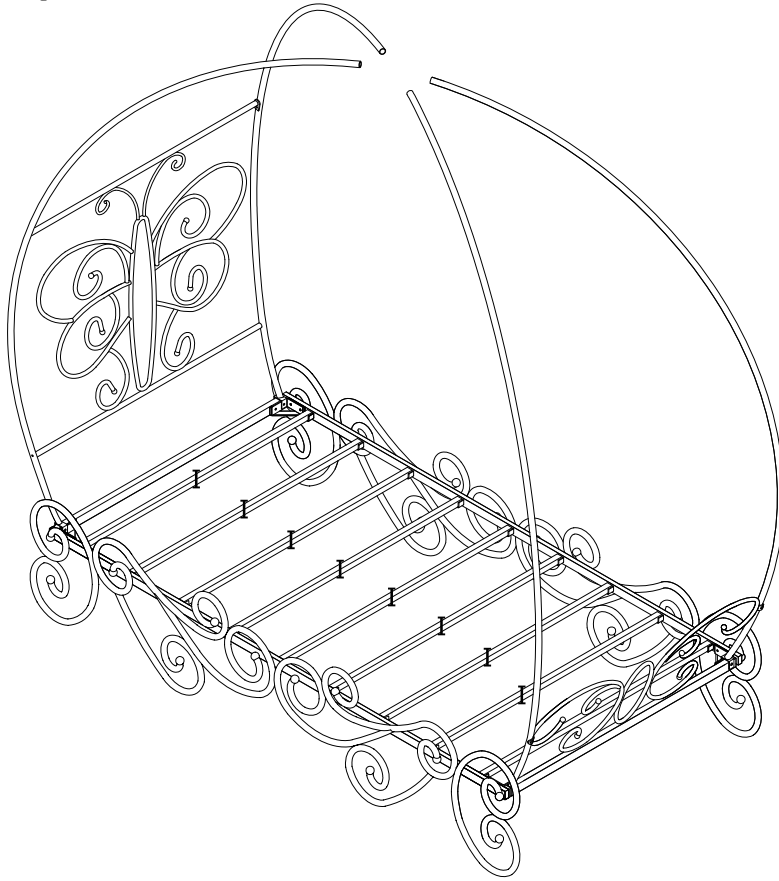

STEP 4.

