

# ASSEMBLY INSTRUCTIONS

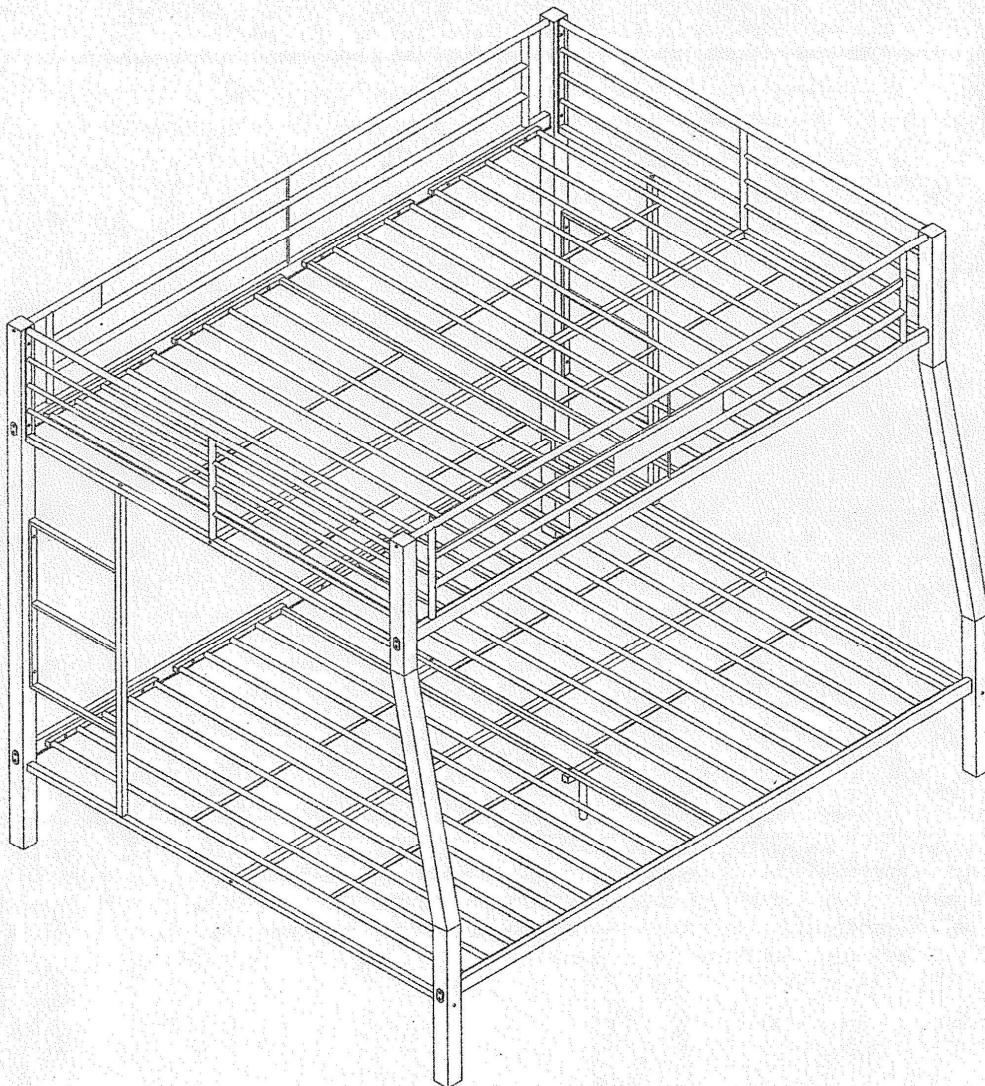

**Do not tighten screws until completely assembled.**

# PARTS IDENTIFICATION

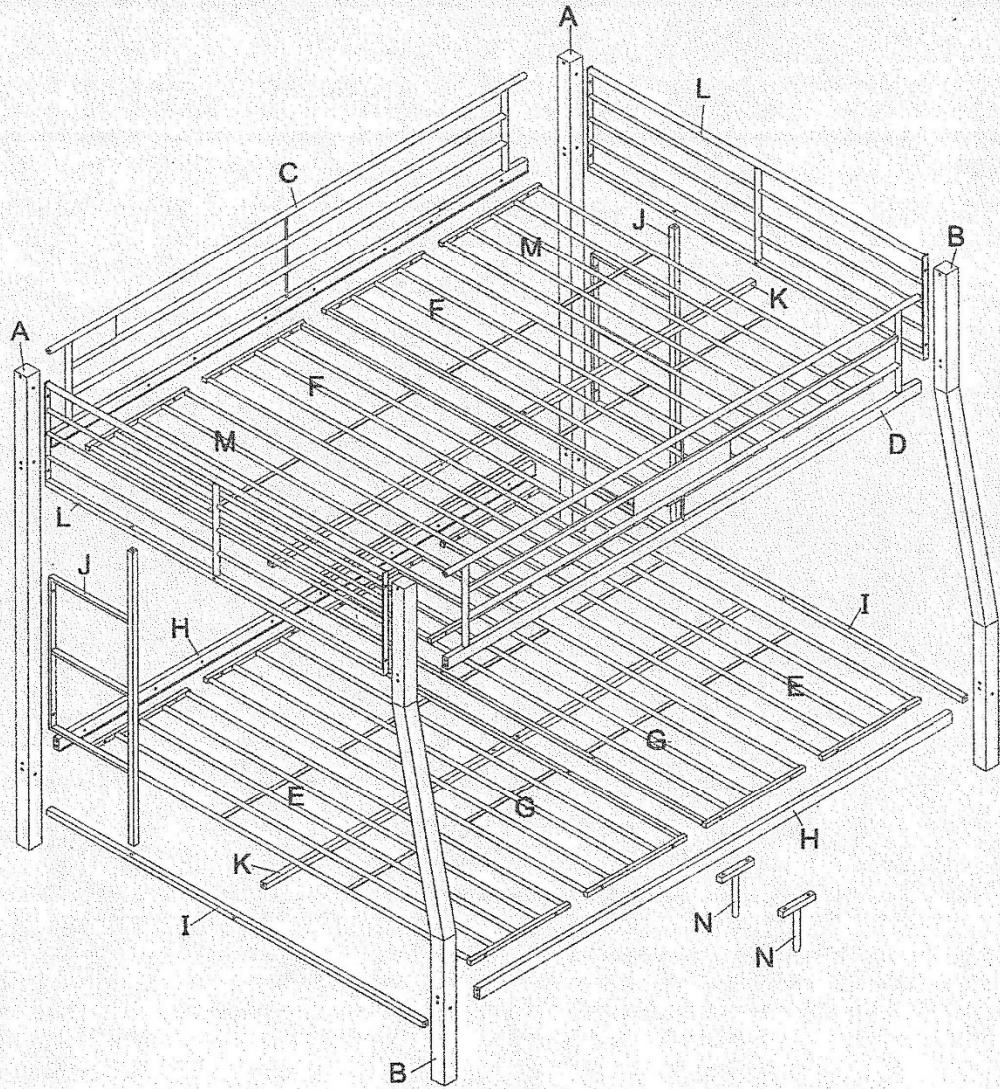

# PARTS IDENTIFICATION

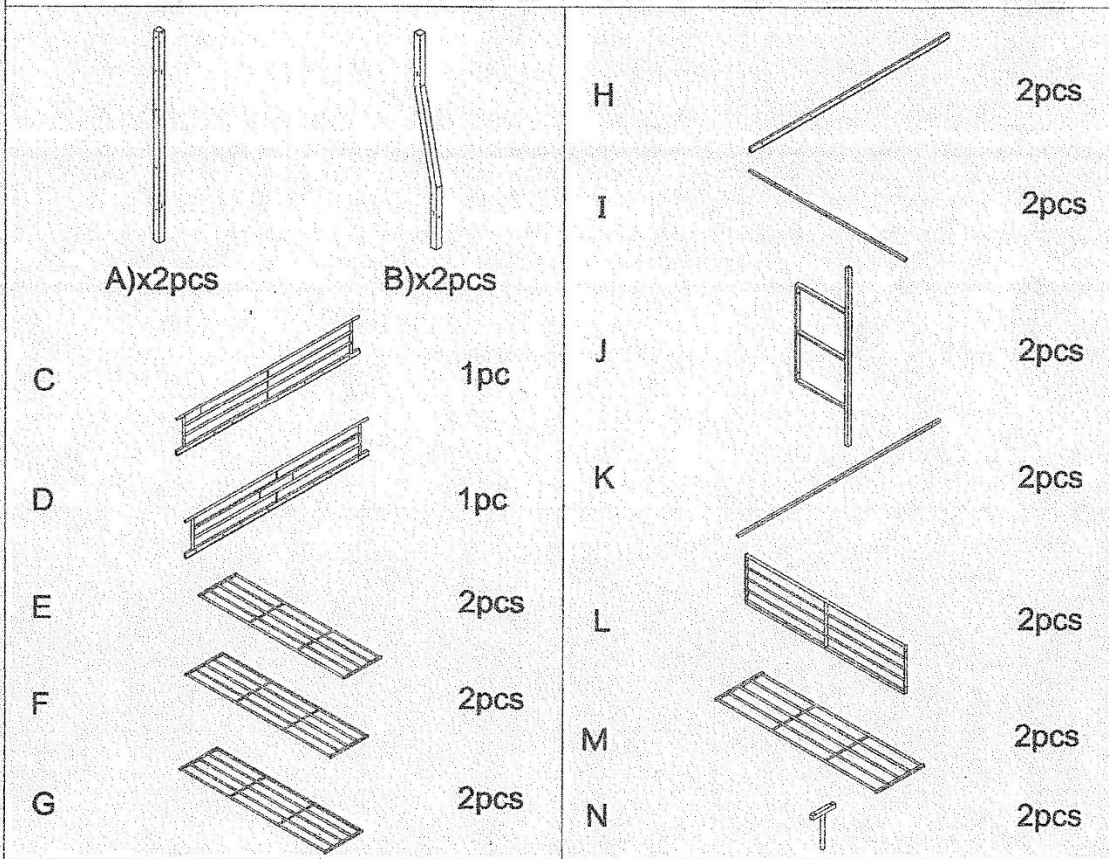

## HARDWARE LIST



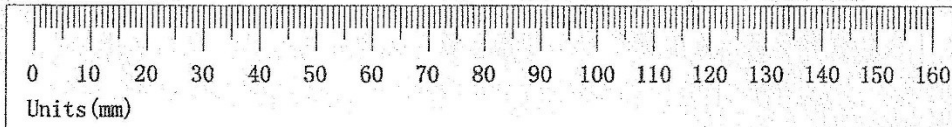

1 M6x15  8pcs	2 M6x25  36pcs	3 M6x30  8pcs
4 M6x35  8pcs	5 8pcs	6 M6x75  8pcs
7 M6x75  16pcs	8 4x4  1pc	



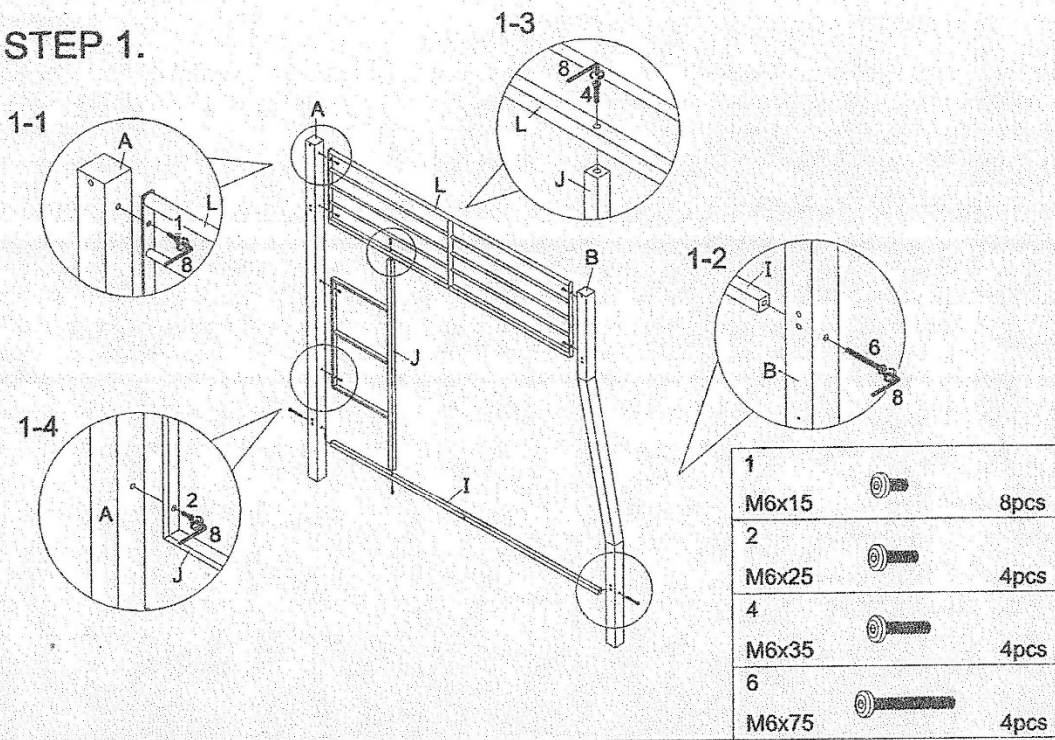





## STEP 1.

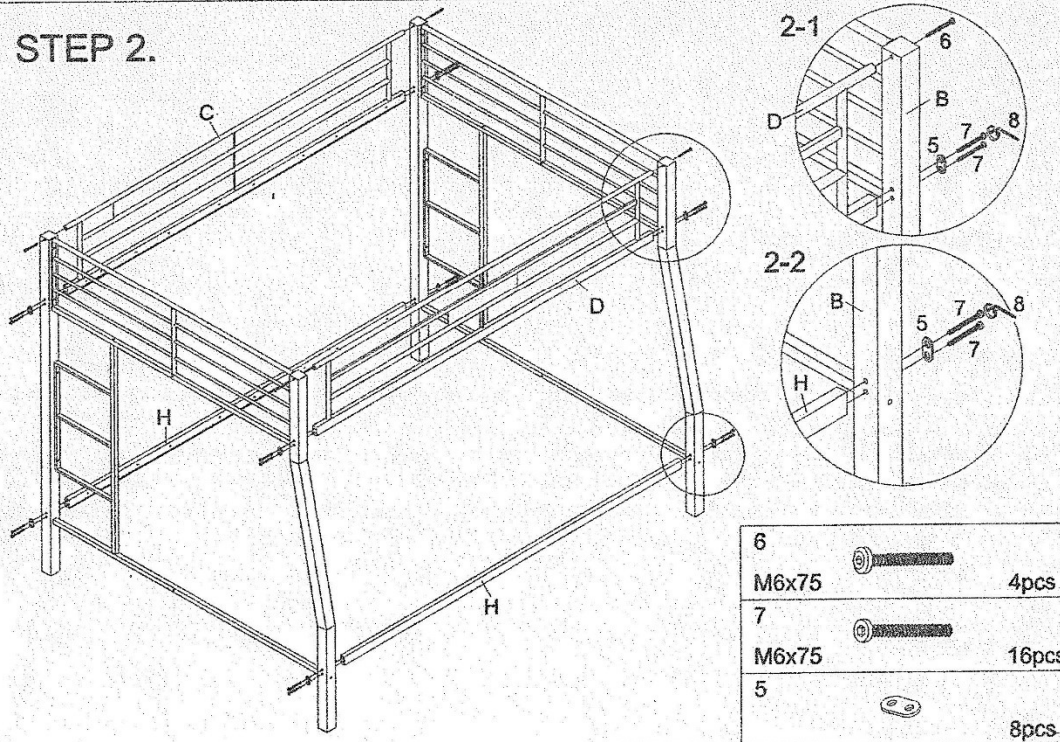

1		8pcs
M6x15		
2		4pcs
M6x25		
4		4pcs
M6x35		
6		4pcs
M6x75		

## STEP 2.



6		4pcs
M6x75		
7		16pcs
M6x75		
5		8pcs



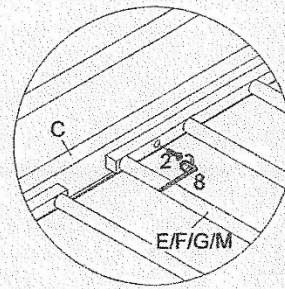
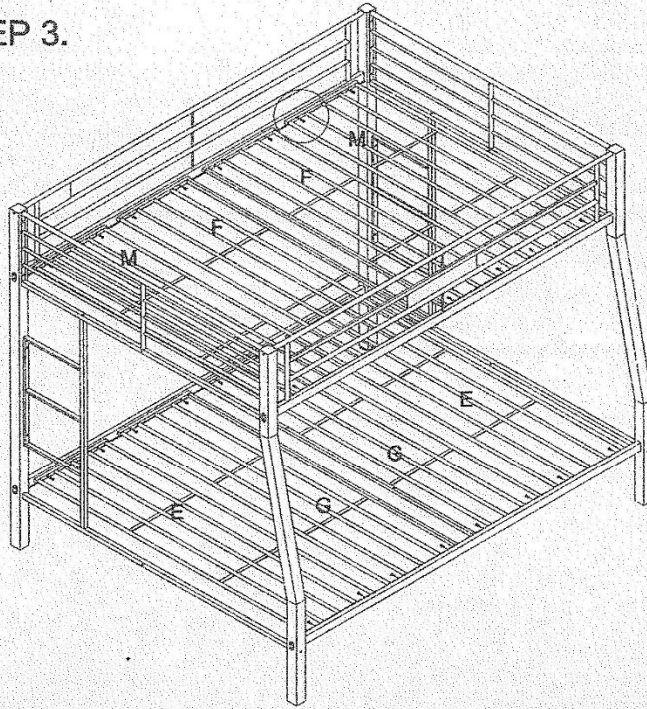

**STEP 3.**

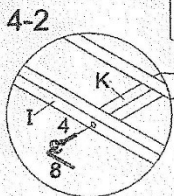
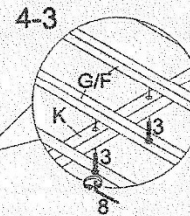
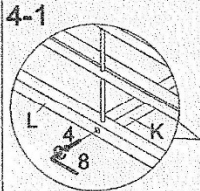
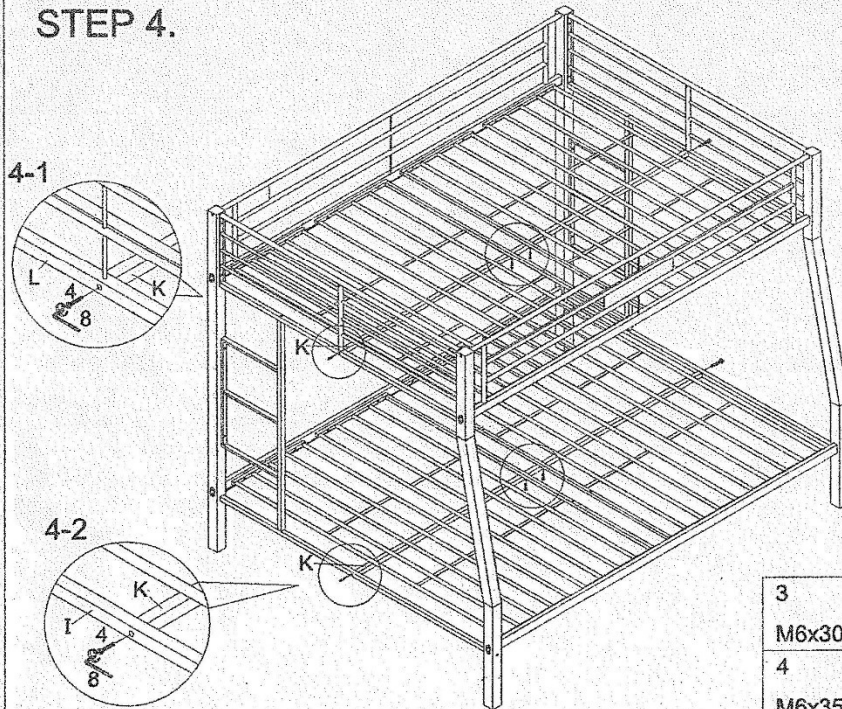

2		
M6x25		32pcs

**STEP 4.**



3		
M6x30		4pcs
4		
M6x35		4pcs

STEP 5.

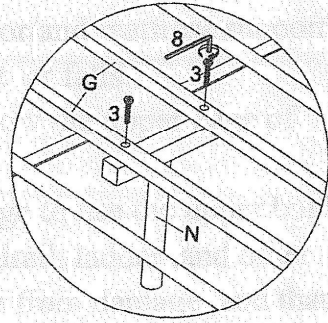
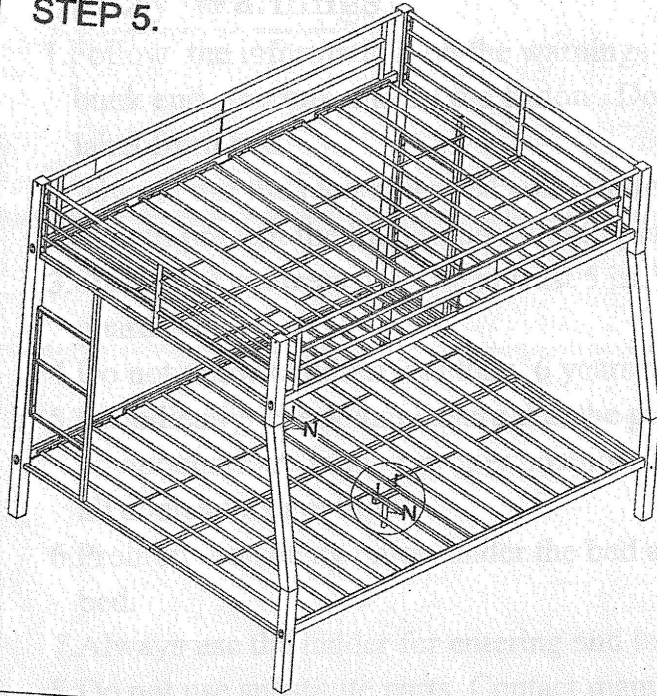

3

M6x30



4pcs

STEP 6.

